

PLAN HISTORY						
DATE	REV.	CONS.	DESCRIPTION	DWN.	CHKD.	MGR.
10.08.20	1		PREPARED BY OFFSHORE HULL OUTFITTING DESIGN TEAM.			
			SUBMITTED TO OWNER FOR REFERENCE.			
			ISSUED FOR WORKING.			

NOTE

- CLASS : ABS
- FLAG : LIBERIA
- DECK HEIGHT : 3000 MM
- CEILING HEIGHT : 2100 MM
- FRAME SPACE : FR. - 15 ~ 18, 202 ~ 238 : 600 MM, FR.18 ~ 202 : 800 MM
- DECK AREA : 483.4 M²
- COMPLEMENT : 60 PERSON
- 1) 2-PERSON CABIN : 30 SET

FOR REFERENCE
Aug. - 20 - 2010
STX Offshore & Shipbuilding Co., Ltd.

ABBREVIATION AND SYMBOL TABLE			
SYMBOL	DESCRIPTION	SYMBOL	DESCRIPTION
	WATER TIGHT STEEL DOOR		WEATHER TIGHT STEEL DOOR
	A-60 CLASS FIRE RETARDING DOOR		A-0 CLASS FIRE RETARDING DOOR
	B-15 CLASS FIRE RETARDING DOOR		C CLASS FIRE RETARDING DOOR
	A-0 SUS WEATHER DOOR (W/SCUTTLE)		NON TIGHT STEEL DOOR
	WATER TIGHT SLIDING DOOR		COLD PROVISION CHAMBER DOOR
	NON-OPENING SIDE SCUTTLE W/DEADLIGHT		NON-OPENING SIDE SCUTTLE
	HINGED SIDE SCUTTLE W/DEADLIGHT		HINGED SIDE SCUTTLE
	NON-OPENING SQUARE WINDOW		HINGED SQUARE WINDOW
	HEATED GLASS WINDOW		WINDOW WIPER
	CURTAIN		PASSAGE STORM RAIL
ABBREV.	DESCRIPTION	ABBREV.	DESCRIPTION
A.C	ARM CHAIR	A.D	ACCESS DOOR
B.C	BOOKCASE	B.R	BOOK RACK
C.B	CUPBOARD	C.C	COMMON CHAIR
C.H	COAT HOOK	C.T	CARD TABLE
CON.T	CONFERENCE TABLE	COR.T	CORNER TABLE
D.W.F	DRINKING WATER FOUNTAIN	E.C	EASY CHAIR
F.C	FILE CABINET	F.H.B	FIRE HOSE BOX
G.L	GAME LOCKER	LKR.	LOCKER
M.L	MEDICINE LOCKER	M.T	MESS TABLE
P.C	COMPUTER TABLE	P.D	PAPER DISPENSER
R.A.C	REVOLVING ARM CHAIR	REF.	REFRIGERATOR
S.B	SIDE BOARD	S.L	STEEL LOCKER
S.R	PASSAGE STORM RAIL	S.T	SIDE TABLE
W.B	WASH BASIN	W.C	WATER CLOSET
W.R	WARDROBE	W.T	WASHING TUB
P.L.C	PILLAR COVER	L.C	LECTURE CHAIR

THIS DRAWING OR DOCUMENT IS THE PROPERTY OF STX OFFSHORE & SHIPBUILDING CO., LTD. AND MUST NOT BE PARTIALLY OR WHOLLY COPIED OR USED FOR ANY OTHER PURPOSE WITHOUT PRIOR WRITTEN PERMISSION OF STX OFFSHORE & SHIPBUILDING.

	HULL NO.	F1004
	TYPE	NOBLE GLOBE TROTTER 2
MANAGER:	S.H. YOON	TITLE
CHECKED:	C.J. YANG	ACCOMMODATION PLAN
	S.H. KIM	(A-DECK)
DRAWN:	S.H. CHOI	
TEL. NO	+82-310-2109	SCALE
DEPT	OFFSHORE HULL OUTFITTING DESIGN TEAM	1:100
	DATE	2010.08.20
	DWG. NO.	84004000
	REV. NO.	1

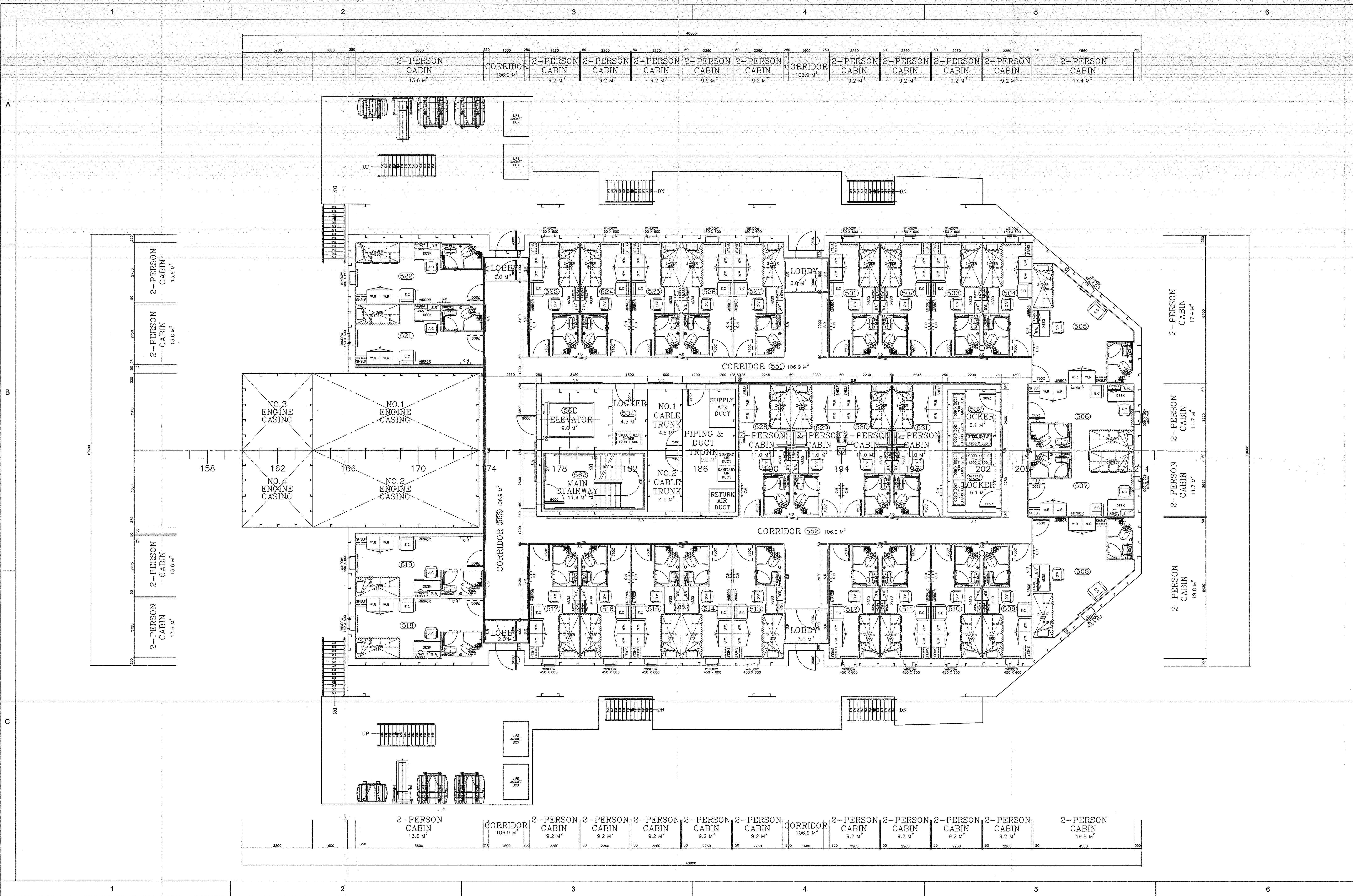

PLAN HISTORY						
DATE	REV.	CONS.	DESCRIPTION	DWN.	CHKD.	MGR.
10.08.20	1		PREPARED BY OFFSHORE HULL OUTFITTING DESIGN TEAM. SUBMITTED TO OWNER FOR REFERENCE. ISSUED FOR WORKING.			

NOTE

- CLASS : ABS
- FLAG : LIBERIAN
- DECK HEIGHT : 3000 MM
- CEILING HEIGHT : 2100 MM
- FRAME SPACE : FR. -15 ~ 18, 202 ~ 238 : 600 MM, FR.18 ~ 202 : 800 MM
- DECK AREA : 496.6 M²
- COMPLEMENT : 60 PERSON
- 1)2-PERSON CABIN : 30 SET

FOR REFERENCE
Aug. - 20 - 2010
STX Offshore & Shipbuilding Co., Ltd.

ABBREVIATION AND SYMBOL TABLE			
SYMBOL	DESCRIPTION	SYMBOL	DESCRIPTION
	WATER TIGHT STEEL DOOR		WEATHER TIGHT STEEL DOOR
	A-60 CLASS FIRE RETARDING DOOR		A-0 CLASS FIRE RETARDING DOOR
	B-15 CLASS FIRE RETARDING DOOR		C CLASS FIRE RETARDING DOOR
	A-0 SUS WEATHER DOOR (W/SCUTTLE)		NON TIGHT STEEL DOOR
	WATER TIGHT SLIDING DOOR		COLD PROVISION CHAMBER DOOR
	NON-OPENING SIDE SCUTTLE W/DEADLIGHT		NON-OPENING SIDE SCUTTLE
	HINGED SIDE SCUTTLE W/DEADLIGHT		HINGED SIDE SCUTTLE
	NON-OPENING SQUARE WINDOW		HINGED SQUARE WINDOW
	HEATED GLASS WINDOW		WINDOW WIPER
	CURTAIN		PASSAGE STORM RAIL

ABBREVI.	DESCRIPTION	ABBREVI.	DESCRIPTION
A.C	ARM CHAIR	A.D	ACCESS DOOR
B.C	BOOKCASE	B.R	BOOK RACK
C.B	CUPBOARD	C.C	COMMON CHAIR
C.H	COAT HOOK	C.T	CARD TABLE
CON.T	CONFERENCE TABLE	COR.T	CORNER TABLE
D.W.F	DRINKING WATER FOUNTAIN	E.C	EASY CHAIR
F.C	FILE CABINET	F.H.B	FIRE HOSE BOX
G.L	GAME LOCKER	L.K.R	LOCKER
M.L	MEDICINE LOCKER	M.T	MESS TABLE
P.C	COMPUTER TABLE	P.D	PAPER DISPENSER
R.A.C	REVOLVING ARM CHAIR	REF.	REFRIGERATOR
S.B	SIDE BOARD	S.L	STEEL LOCKER
S.R	PASSAGE STORM RAIL	S.T	SIDE TABLE
W.B	WASH BASIN	W.C	WATER CLOSET
W.R	WARDROBE	W.T	WASHING TUB
PL.C	PILLAR COVER	L.C	LECTURE CHAIR

THIS DRAWING OR DOCUMENT IS THE PROPERTY OF STX OFFSHORE & SHIPBUILDING CO., LTD. AND MUST NOT BE PARTIALLY OR WHOLLY COPIED OR USED FOR ANY OTHER PURPOSE WITHOUT PRIOR WRITTEN PERMISSION OF STX OFFSHORE & SHIPBUILDING.

	HULL NO.	F 1004
	TYPE	NOBLE GLOBE TROTTER 2
MANAGER :	S.H. YOON	TITLE
CHECKED :	C.J. YANG	
	S.H. KIM	ACCOMMODATION PLAN (B-DECK)
DRAWN :	S.H. CHOI	
TEL. NO.	+82-2-310-2109	
DEPT.	OFFSHORE HULL OUTFITTING DESIGN TEAM	SCALE
		DATE
		DWG. NO.
		REV. NO.

CASING	2-PERSON CABIN 10.6 M ²	2-PERSON CABIN 10.6 M ²	CORRIDOR 119.1 M ²	2-PERSON CABIN 9.5 M ²	2-PERSON CABIN 9.5 M ²	1-PERSON CABIN 14.1 M ²	1-PERSON CABIN 14.1 M ²	CORRIDOR 119.1 M ²	1-PERSON CABIN 15.0 M ²	1-PERSON CABIN 15.0 M ²	1-PERSON CABIN 15.1 M ²
--------	---------------------------------------	---------------------------------------	----------------------------------	--------------------------------------	--------------------------------------	---------------------------------------	---------------------------------------	----------------------------------	---------------------------------------	---------------------------------------	---------------------------------------

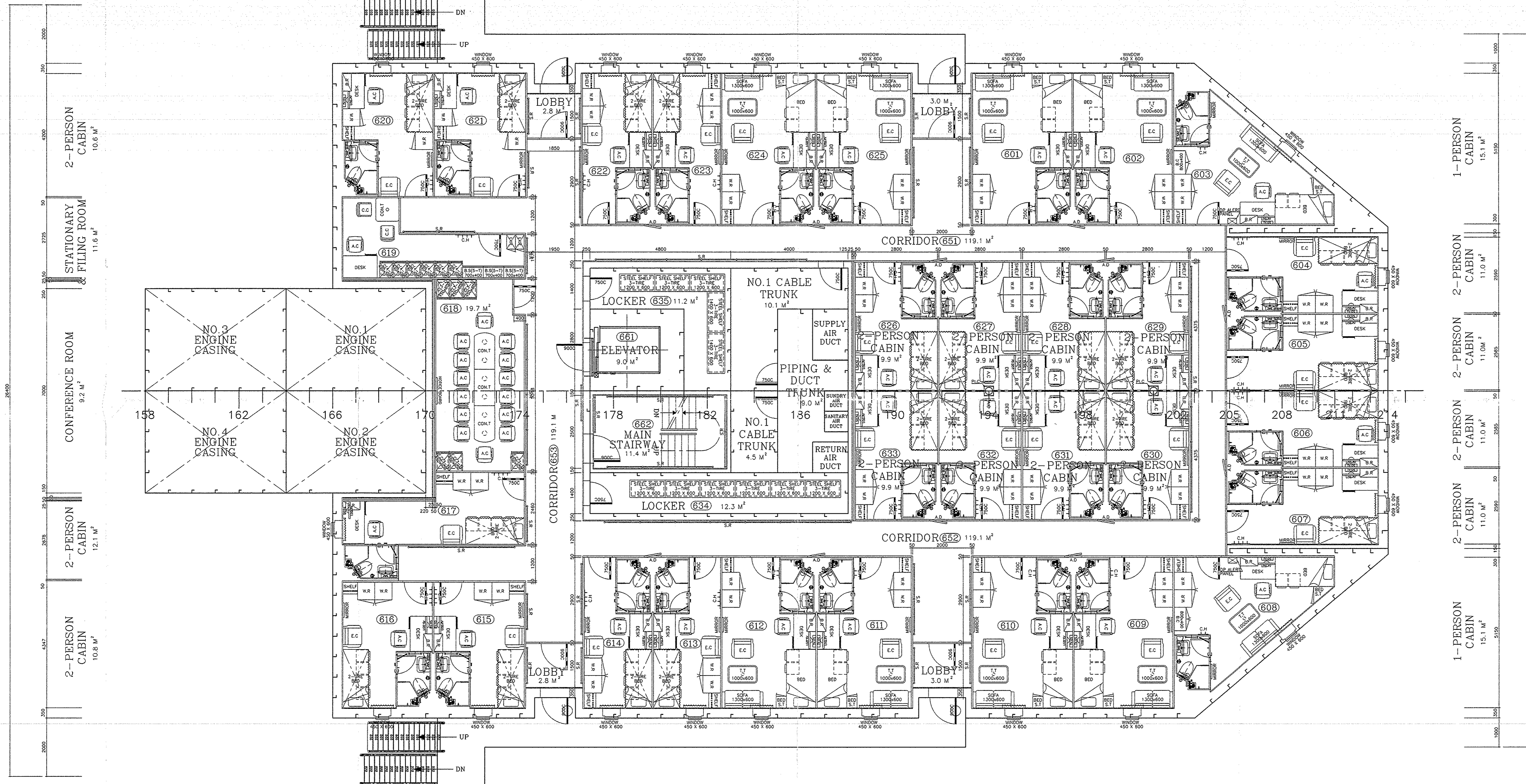

CASING	CABIN 2-PERSON 10.8 M ²	CABIN 2-PERSON 10.8 M ²	CORRIDOR 119.1 M ²	CABIN 2-PERSON 9.5 M ²	CABIN 2-PERSON 9.5 M ²	CABIN 1-PERSON 14.1 M ²	CABIN 1-PERSON 14.1 M ²	CORRIDOR 119.1 M ²	CABIN 1-PERSON 15.0 M ²	CABIN 1-PERSON 15.0 M ²	CABIN 1-PERSON 15.1 M ²
--------	--	--	----------------------------------	---	---	--	--	----------------------------------	--	--	--

PLAN HISTORY

DATE	REV.	CONS.	DESCRIPTION	DWN.	CHKD.	MGR.
10.08.20	△		PREPARED BY OFFSHORE HULL OUTFITTING DESIGN TEAM. SUBMITTED TO OWNER FOR REFERENCE. ISSUED FOR WORKING.			

FOR REFERENCE
Aug. - 20 - 2010
STX Offshore & Shipbuilding Co., Ltd.

- NOTE**
- CLASS : ABS
 - FLAG : LIBERIAN
 - DECK HEIGHT : 3000 MM
 - CEILING HEIGHT : 2100 MM
 - FRAME SPACE : FR. -15 ~ 18, 202 ~ 238 : 600 MM, FR.18 ~ 202 : 800 MM
 - DECK AREA : 589.1 M²
 - COMPLEMENT : 52 PERSON
1) 1-PERSON CABIN : 10 SET
2) 2-PERSON CABIN : 21 SET

ABBREVIATION AND SYMBOL TABLE

SYMBOL	DESCRIPTION	SYMBOL	DESCRIPTION
	WATER TIGHT STEEL DOOR		WEATHER TIGHT STEEL DOOR
	A-60 CLASS FIRE RETARDING DOOR		A-0 CLASS FIRE RETARDING DOOR
	B-15 CLASS FIRE RETARDING DOOR		C CLASS FIRE RETARDING DOOR
	A-0 SUS WEATHER DOOR (W/SCUTTLE)		NON TIGHT STEEL DOOR
	WATER TIGHT SLIDING DOOR		COLD PROVISION CHAMBER DOOR
	NON-OPENING SIDE SCUTTLE W/DEADLIGHT		NON-OPENING SIDE SCUTTLE
	HINGED SIDE SCUTTLE W/DEADLIGHT		HINGED SIDE SCUTTLE
	NON-OPENING SQUARE WINDOW		HINGED SQUARE WINDOW
	HEATED GLASS WINDOW		WINDOW WIPER
	CURTAIN		PASSAGE STORM RAIL
ABBREV.	DESCRIPTION	ABBREV.	DESCRIPTION
A.C	ARM CHAIR	A.D	ACCESS DOOR
B.C	BOOKCASE	B.R	BOOK RACK
C.B	CUPBOARD	C.C	COMMON CHAIR
C.H	COAT HOOK	C.T	CARD TABLE
CON.T	CONFERENCE TABLE	COR.T	CORNER TABLE
D.W.F	DRINKING WATER FOUNTAIN	E.C	EASY CHAIR
F.C	FILE CABINET	F.H.B	FIRE HOSE BOX
G.L	GAME LOCKER	L.K.R	LOCKER
M.L	MEDICINE LOCKER	M.T	MESS TABLE
P.C	COMPUTER TABLE	P.D	PAPER DISPENSER
R.A.C	REVOLVING ARM CHAIR	REF.	REFRIGERATOR
S.B	SIDE BOARD	S.L	STEEL LOCKER
S.R	PASSAGE STORM RAIL	S.T	SIDE TABLE
W.B	WASH BASIN	W.C	WATER CLOSET
W.R	WARDROBE	W.T	WASHING TUB
P.L.C	PILLAR COVER	L.C	LECTURE CHAIR

THIS DRAWING OR DOCUMENT IS THE PROPERTY OF STX OFFSHORE & SHIPBUILDING CO., LTD. AND MUST NOT BE PARTIALLY OR WHOLLY COPIED OR USED FOR ANY OTHER PURPOSE WITHOUT PRIOR WRITTEN PERMISSION OF STX OFFSHORE & SHIPBUILDING.

	HULL NO.	F 1004			
	TYPE	NOBLE GLOBE TROTTER 2			
MANAGER:	S.H. YOON	TITLE ACCOMMODATION PLAN (C-DECK)			
CHECKED:	C.J. YANG				
DRAWN:	S.H. CHOI				
TEL. NO.	+82-2-310-2109	SCALE	DATE	DWG. NO.	REV. NO.
DEPT	OFFSHORE HULL OUTFITTING DESIGN TEAM	1:100	2010.08.20	B4006000	△

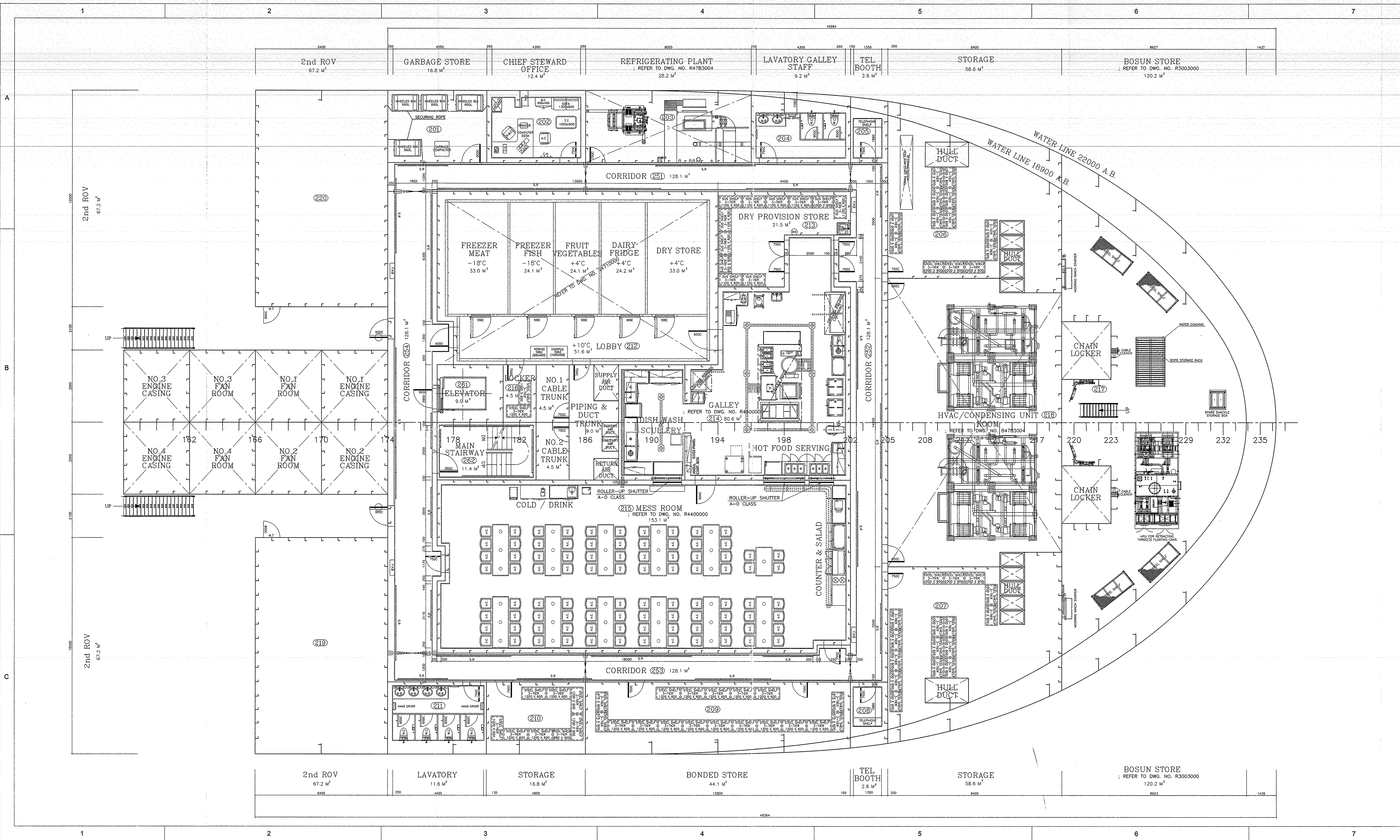

PLAN HISTORY						
DATE	REV.	CONS.	DESCRIPTION	DWN.	CHKD.	MGR.
10.08.20	△		PREPARED BY OFFSHORE HULL OUTFITTING DESIGN TEAM.			
			SUBMITTED TO OWNER FOR REFERENCE.			
			ISSUED FOR WORKING.			

NOTE
 1. CLASS : ABS
 2. FLAG : LIBERIAN
 3. DECK HEIGHT : 4200 MM
 4. CEILING HEIGHT : 2300 MM
 5. FRAME SPACE : FR. -15 ~ 18, 202 ~ 238 : 600 MM, FR.18 ~ 202 : 800 MM
 6. DECK AREA : 1388.5 M²

FOR REFERENCE
 Aug.-2010
 STX Offshore & Shipbuilding Co., Ltd.

ABBREVIATION AND SYMBOL TABLE			
SYMBOL	DESCRIPTION	SYMBOL	DESCRIPTION
	WATER TIGHT STEEL DOOR		WEATHER TIGHT STEEL DOOR
	A-60 CLASS FIRE RETARDING DOOR		A-0 CLASS FIRE RETARDING DOOR
	B-15 CLASS FIRE RETARDING DOOR		C CLASS FIRE RETARDING DOOR
	A-0 SUS WEATHER DOOR (W/SCUTTLE)		NON TIGHT STEEL DOOR
	WATER TIGHT SLIDING DOOR		COLD PROVISION CHAMBER DOOR
	NON-OPENING SIDE SCUTTLE W/DEADLIGHT		NON-OPENING SIDE SCUTTLE
	HINGED SIDE SCUTTLE W/DEADLIGHT		HINGED SIDE SCUTTLE
	NON-OPENING SQUARE WINDOW		HINGED SQUARE WINDOW
	HEATED GLASS WINDOW		WINDOW WIPER
	CURTAIN		PASSAGE STORM RAIL
ABBREV.	DESCRIPTION	ABBREV.	DESCRIPTION
A.C	ARM CHAIR	A.D	ACCESS DOOR
B.C	BOOKCASE	B.R	BOOK RACK
C.B	CUPBOARD	C.C	COMMON CHAIR
C.H	COAT HOOK	C.T	CARD TABLE
CON.T	CONFERENCE TABLE	COR.T	CORNER TABLE
D.W.F	DRINKING WATER FOUNTAIN	E.C	EASY CHAIR
F.C	FILE CABINET	F.H.B	FIRE HOSE BOX
G.L	GAME LOCKER	L.K.R	LOCKER
M.L	MEDICINE LOCKER	M.T	MESS TABLE
P.C	COMPUTER TABLE	P.D	PAPER DISPENSER
R.A.C	REVOLVING ARM CHAIR	REF.	REFRIGERATOR
S.B	SIDE BOARD	S.L	STEEL LOCKER
S.R	PASSAGE STORM RAIL	S.T	SIDE TABLE
W.B	WASH BASIN	W.C	WATER CLOSET
W.R	WARDROBE	W.T	WASHING TUB
P.I.C	PILLAR COVER	L.C	LECTURE CHAIR

THIS DRAWING OR DOCUMENT IS THE PROPERTY OF STX OFFSHORE & SHIPBUILDING CO., LTD. AND MUST NOT BE PARTIALLY OR WHOLLY COPIED OR USED FOR ANY OTHER PURPOSE WITHOUT PRIOR WRITTEN PERMISSION OF STX OFFSHORE & SHIPBUILDING.

STX	HULL NO.	F 1004			
	TYPE	NOBLE GLOBE TROTTER 2			
MANAGER :	S.H. YOON	TITLE			
CHECKED :	C.J. YANG	ACCOMMODATION PLAN (MAIN-DECK)			
	S.H. KIM				
DRAWN :	C.M.PARK				
TEL. NO.	+82-2-310-2418	SCALE	DATE	DWG. NO.	REV. NO.
DEPT	OFFSHORE HULL OUTFITTING DESIGN TEAM	1:100	2010.08.20	B4002000	△

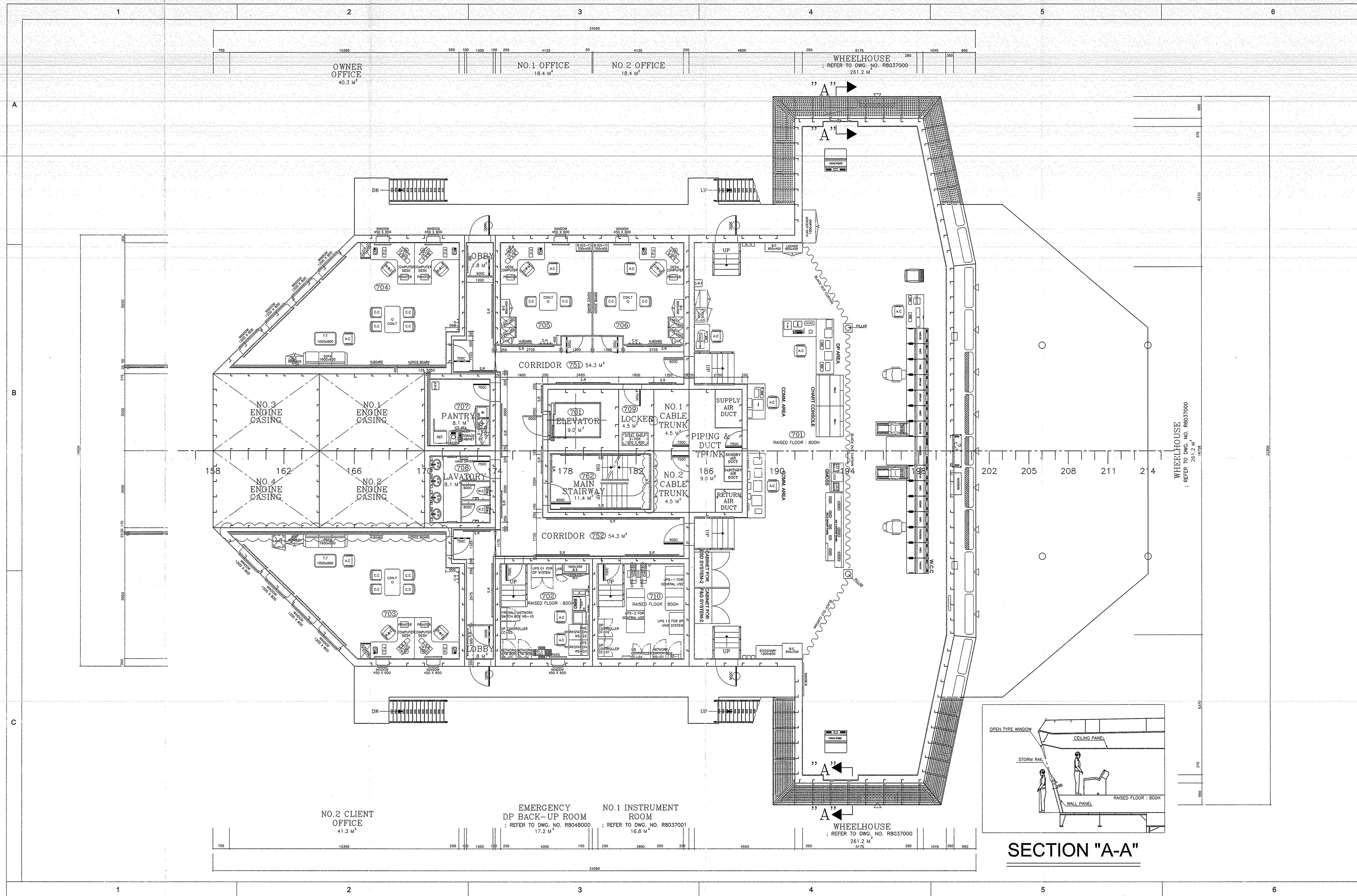

PLAN HISTORY						
DATE	REV.	CONS.	DESCRIPTION	DWN.	CHKD.	MGR.
10.08.20	△		PREPARED BY OFFSHORE HULL OUTFITTING DESIGN TEAM.			
			SUBMITTED TO OWNER FOR REFERENCE.			
			ISSUED FOR WORKING.			

FOR REFERENCE
 Aug. - 20 - 2010
 STX Offshore & Shipbuilding Co., Ltd.

- NOTE**
- CLASS : ABS
 - FLAG : LIBERIA
 - DECK HEIGHT : 4300 MM (RAISED FLOOR : 800MM ABOVE)
 - CEILING HEIGHT : 2100 MM
 - FRAME SPACE : FR. -15 ~ 18, 202 ~ 238 : 600 MM, FR.18 ~ 202 : 800 MM
 - DECK AREA : 530.6 M²

ABBREVIATION AND SYMBOL TABLE			
SYMBOL	DESCRIPTION	SYMBOL	DESCRIPTION
	WATER TIGHT STEEL DOOR		WEATHER TIGHT STEEL DOOR
	A-60 CLASS FIRE RETARDING DOOR		A-0 CLASS FIRE RETARDING DOOR
	B-15 CLASS FIRE RETARDING DOOR		C CLASS FIRE RETARDING DOOR
	A-0 SUS WEATHER DOOR (W/SCUTTLE)		NON TIGHT STEEL DOOR
	WATER TIGHT SLIDING DOOR		COLD PROVISION CHAMBER DOOR
	NON-OPENING SIDE SCUTTLE W/DEADLIGHT		NON-OPENING SIDE SCUTTLE
	HINGED SIDE SCUTTLE W/DEADLIGHT		HINGED SIDE SCUTTLE
	NON-OPENING SQUARE WINDOW		HINGED SQUARE WINDOW
	HEATED GLASS WINDOW		WINDOW WIPER
	CURTAIN		PASSAGE STORM RAIL
ABBREV.	DESCRIPTION	ABBREV.	DESCRIPTION
A.C	ARM CHAIR	A.D	ACCESS DOOR
B.C	BOOKCASE	B.R	BOOK RACK
C.B	CLIPBOARD	C.C	COMMON CHAIR
C.H	COAT HOOK	C.T	CARD TABLE
CON.T	CONFERENCE TABLE	COR.T	CORNER TABLE
D.W.F	DRINKING WATER FOUNTAIN	E.C	EASY CHAIR
F.C	FILE CABINET	F.H.B	FIRE HOSE BOX
G.L	GAME LOCKER	L.K.R	LOCKER
M.L	MEDICINE LOCKER	M.T	MESS TABLE
P.C	COMPUTER TABLE	P.D	PAPER DISPENSER
R.A.C	REVOLVING ARM CHAIR	REF.	REFRIGERATOR
S.B	SIDE BOARD	S.L	STEEL LOCKER
S.R	PASSAGE STORM RAIL	S.T	SIDE TABLE
W.B	WASH BASIN	W.C	WATER CLOSET
W.R	WARDROBE	W.T	WASHING TUB
P.L.C	PILLAR COVER	L.C	LECTURE CHAIR

THIS DRAWING OR DOCUMENT IS THE PROPERTY OF STX OFFSHORE & SHIPBUILDING CO., LTD. AND MUST NOT BE PARTIALLY OR WHOLLY COPIED OR USED FOR ANY OTHER PURPOSE WITHOUT PRIOR WRITTEN PERMISSION OF STX OFFSHORE & SHIPBUILDING.

stx	HULL NO.	F1004
	TYPE	NOBLE GLOBE TROTTER 2
MANAGER:	S.H. YOON	TITLE
CHECKED:	C.J. YANG	ACCOMMODATION PLAN (NAV. DECK)
	S.H. KIM	
DRAWN:	J.H. LEE	
TEL NO	+82-310-2188	SCALE
DEPT	OFFSHORE HULL OUTFITTING DESIGN TEAM	DATE
		2010.08.20
		DWG. NO.
		B4007000
		REV. NO.
		△

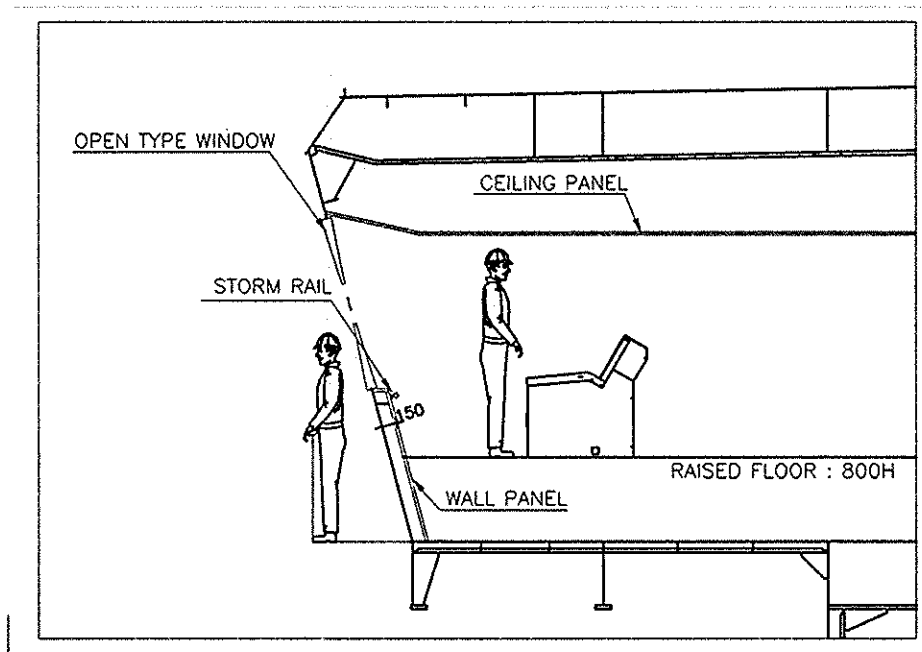

SECTION "A-A"

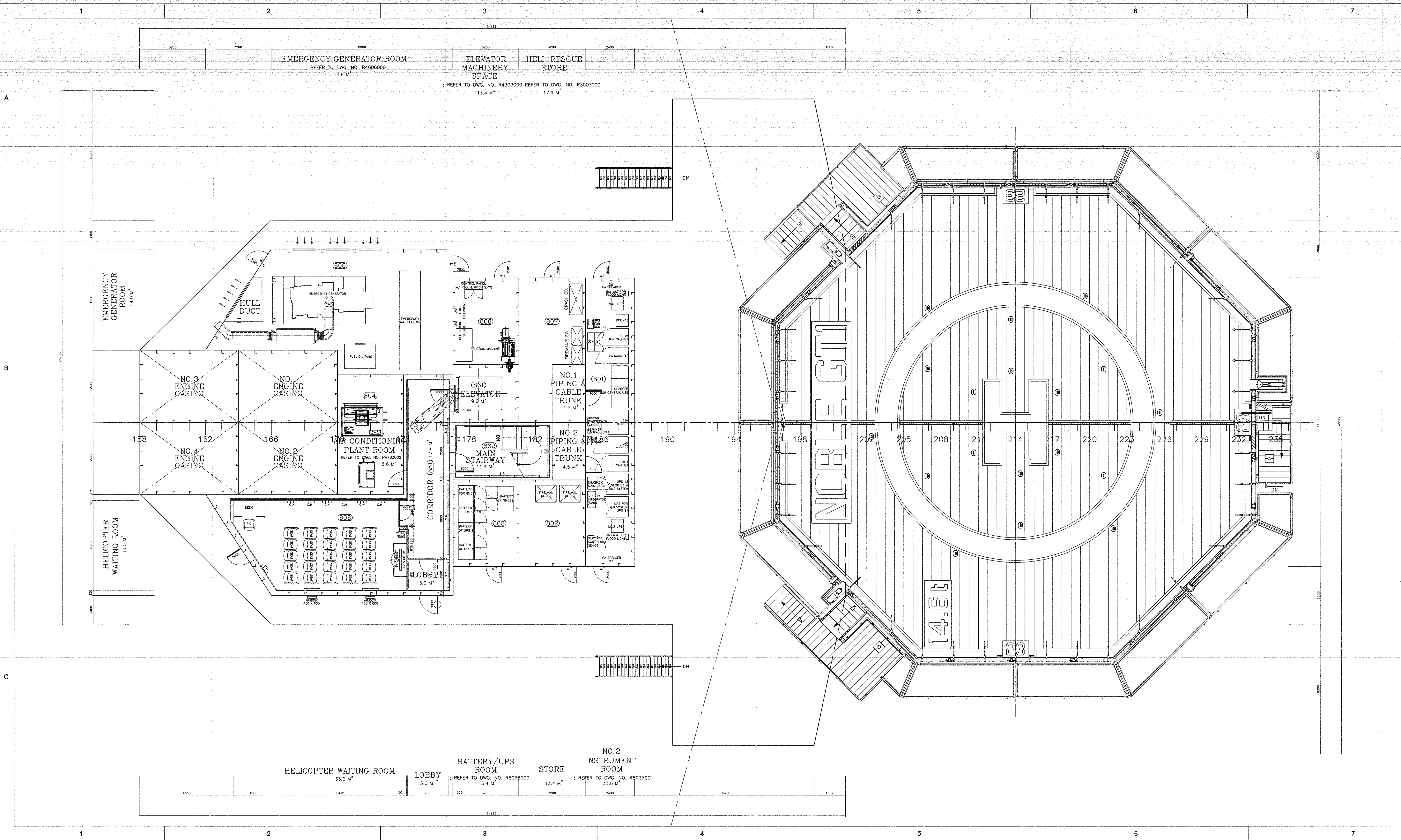

PLAN HISTORY						
DATE	REV.	CONS.	DESCRIPTION	DWN.	CHKD.	MGR.
10.08.20	1		PREPARED BY OFFSHORE HULL OUTFITTING DESIGN TEAM.			
			SUBMITTED TO OWNER FOR REFERENCE.			
			ISSUED FOR WORKING.			

NOTE
 1. CLASS : ABS
 2. FLAG : LIBERIAN
 3. DECK HEIGHT : 4600 MM
 4. CEILING HEIGHT : 2100 MM
 5. FRAME SPACE : FR. ~15 ~ 18, 202 ~ 238 : 600 MM, FR.18 ~ 202 : 800 MM
 6. DECK AREA : 251.4 M²

FOR REFERENCE
 Aug. - 20 - 2010
 STX Offshore & Shipbuilding Co., Ltd.

ABBREVIATION AND SYMBOL TABLE			
SYMBOL	DESCRIPTION	SYMBOL	DESCRIPTION
	WATER TIGHT STEEL DOOR		WEATHER TIGHT STEEL DOOR
	A-60 CLASS FIRE RETARDING DOOR		A-0 CLASS FIRE RETARDING DOOR
	B-15 CLASS FIRE RETARDING DOOR		C CLASS FIRE RETARDING DOOR
	A-0 SUS WEATHER DOOR (W/SCUTTLE)		NON TIGHT STEEL DOOR
	WATER TIGHT SLIDING DOOR		COLD PROVISION CHAMBER DOOR
	NON-OPENING SIDE SCUTTLE W/DEADLIGHT		NON-OPENING SIDE SCUTTLE
	HINGED SIDE SCUTTLE W/DEADLIGHT		HINGED SIDE SCUTTLE
	NON-OPENING SQUARE WINDOW		HINGED SQUARE WINDOW
	HEATED GLASS WINDOW		WINDOW WIPER
	CURTAIN		PASSAGE STORM RAIL

ABBREV.	DESCRIPTION	ABBREV.	DESCRIPTION
A.C	ARM CHAIR	A.D	ACCESS DOOR
B.C	BOOKCASE	B.R	BOOK RACK
C.B	CUPBOARD	C.C	COMMON CHAIR
C.H	COAT HOOK	C.T	CARD TABLE
CON.T	CONFERENCE TABLE	COR.T	CORNER TABLE
D.W.F	DRINKING WATER FOUNTAIN	E.C	EASY CHAIR
F.C	FILE CABINET	F.H.B	FIRE HOSE BOX
G.L	GAME LOCKER	LKR.	LOCKER
M.L	MEDICINE LOCKER	M.T	MESS TABLE
P.C	COMPUTER TABLE	P.D	PAPER DISPENSER
R.A.C	REVOLVING ARM CHAIR	REF.	REFRIGERATOR
S.B	SIDE BOARD	S.L	STEEL LOCKER
S.R	PASSAGE STORM RAIL	S.T	SIDE TABLE
W.B	WASH BASIN	W.C	WATER CLOSET
W.R	WARDROBE	W.T	WASHING TUB
PL.C	PILLAR COVER	L.C	LECTURE CHAIR

THIS DRAWING OR DOCUMENT IS THE PROPERTY OF STX OFFSHORE & SHIPBUILDING CO., LTD. AND MUST NOT BE PARTIALLY OR WHOLLY COPIED OR USED FOR ANY OTHER PURPOSE WITHOUT PRIOR WRITTEN PERMISSION OF STX OFFSHORE & SHIPBUILDING CO., LTD.

	HULL NO.	F1004
	TYPE	NOBLE GLOBE TROTTER 2
MANAGER :	S.H. YOON	TITLE
CHECKED :	C.J. YANG	ACCOMMODATION PLAN
	S.H. KIM	(TOP-DECK)
DRAWN :	J.H. LEE	
TEL. NO	+82-519-2198	
DEPT	OFFSHORE HULL OUTFITTING DESIGN TEAM	
SCALE	1:100	
DATE	2010.08.20	
DWG. NO.	84008000	
REV. NO.	1	

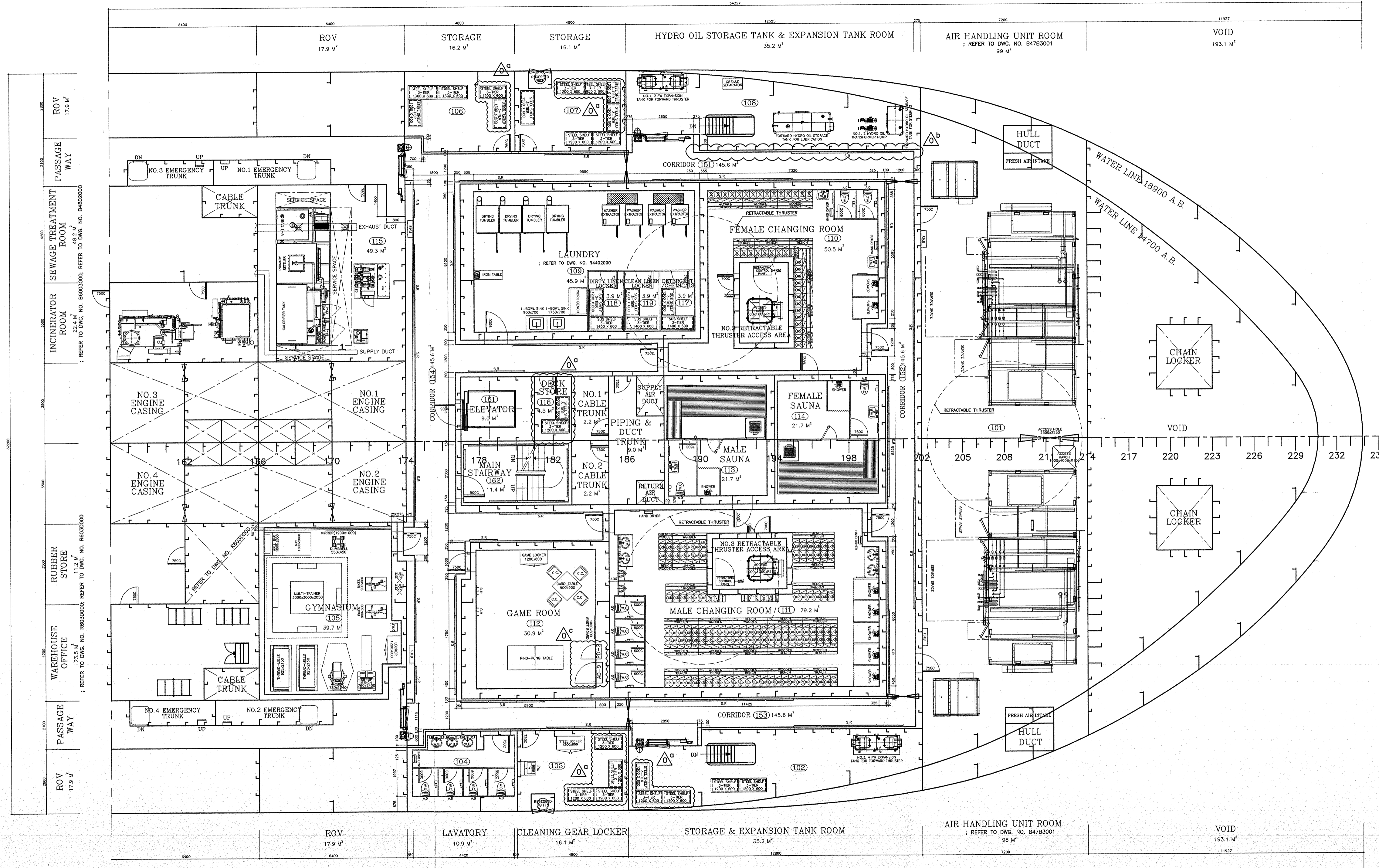

PLAN HISTORY

DATE	REV.	CONS.	DESCRIPTION	DWN.	CHKD.	MGR.
10.09.10	△		PREPARED BY OFFSHORE HULL OUTFITTING DESIGN TEAM. ISSUED FOR APPROVAL TO OWNER & CLASS. ISSUED FOR WORKING.			
11.03.11	△		FOLLOWING ITEMS HAVE BEEN MODIFIED ACCORDING TO DESIGN IMPROVEMENT: - CHANGED ITEMS POSITION & SIZE OF SHELF.(RM.102,103,106,107,116) a - POSITION & SIZE OF SHELF.(RM.108) b - ADDED ITEMS ELECTRICAL PANEL(AD-9,PD-2).(RM.112) c ISSUED FOR CONFIRMATION TO OWNER & CLASS. ISSUED FOR CONSTRUCTION.		E.J.KIM C.J.YANG S.H.YOON	

FOR CONFIRMATION
2011. 03. 11
STX Offshore & Shipbuilding Co., Ltd.

- NOTE**
- CLASS : ABS
 - FLAG : LIBERIAN
 - DECK HEIGHT : 4200 MM
 - CEILING HEIGHT : 2300 MM
 - FRAME SPACE : FR. -15 ~ 18, 202 ~ 238 : 600 MM, FR.18 ~ 202 : 800 MM
 - DECK AREA : 1388.5 M²

ABBREVIATION AND SYMBOL TABLE

SYMBOL	DESCRIPTION	SYMBOL	DESCRIPTION
	WATER TIGHT STEEL DOOR		WEATHER TIGHT STEEL DOOR
	A-60 CLASS FIRE RETARDING DOOR		A-0 CLASS FIRE RETARDING DOOR
	B-15 CLASS FIRE RETARDING DOOR		C CLASS FIRE RETARDING DOOR
	A-0 SUS WEATHER DOOR (W/SCUTTLE)		NON TIGHT STEEL DOOR
	WATER TIGHT SLIDING DOOR		COLD PROVISION CHAMBER DOOR
	NON-OPENING SIDE SCUTTLE W/DEADLIGHT		NON-OPENING SIDE SCUTTLE
	HINGED SIDE SCUTTLE W/DEADLIGHT		HINGED SIDE SCUTTLE
	NON-OPENING SQUARE WINDOW		HINGED SQUARE WINDOW
	HEATED GLASS WINDOW		WINDOW WIPER
	CURTAIN		PASSAGE STORM RAIL
ABBREV.	DESCRIPTION	ABBREV.	DESCRIPTION
A.C	ARM CHAIR	A.D	ACCESS DOOR
B.C	BOOKCASE	B.R	BOOK RACK
C.B	CUPBOARD	C.C	COMMON CHAIR
C.H	COAT HOOK	C.T	CARD TABLE
CON.T	CONFERENCE TABLE	COR.T	CORNER TABLE
D.W.F	DRINKING WATER FOUNTAIN	E.C	EASY CHAIR
F.C	FILE CABINET	F.H.B	FIRE HOSE BOX
G.L	GAME LOCKER	LKR.	LOCKER
M.L	MEDICINE LOCKER	M.T	MESS TABLE
P.C	COMPUTER TABLE	P.D	PAPER DISPENSER
R.A.C	REVOLVING ARM CHAIR	REF.	REFRIGERATOR
S.B	SIDE BOARD	S.L	STEEL LOCKER
S.R	PASSAGE STORM RAIL	S.T	SIDE TABLE
W.B	WASH BASIN	W.C	WATER CLOSET
W.R	WARDROBE	W.T	WASHING TUB
P.L.C	PILLAR COVER	L.C	LECTURE CHAIR

THIS DRAWING ON DOCUMENT IS THE PROPERTY OF STX OFFSHORE & SHIPBUILDING CO., LTD. AND MUST NOT BE PARTIALLY OR WHOLLY COPIED OR USED FOR ANY OTHER PURPOSE WITHOUT PRIOR WRITTEN PERMISSION OF STX OFFSHORE & SHIPBUILDING.

	HULL NO. F1004
TYPE NOBLE GLOBE TROTTER 2	TITLE
MANAGER : S.H. YOON	ACCOMMODATION PLAN (UPPER TWEEN DECK)
CHECKED : C.J. YANG J.Y. LEE	
DRAWN : E.J. KIM	
TEL. NO. +82-2-310-2104	SCALE 1:100
DEPT. OFFSHORE HULL OUTFITTING DESIGN TEAM	DATE 2010.09.10
	DWG. NO. 8401000
	REV. NO. △

PLAN HISTORY						
DATE	REV.	CONS.	DESCRIPTION	DWN.	CHKD.	MGR.
10.08.20	A		PREPARED BY OFFSHORE HULL OUTFITTING DESIGN TEAM. SUBMITTED TO OWNER FOR REFERENCE. ISSUED FOR WORKING.			

NOTE

- CLASS : ABS
- FLAG : LIBERIA
- DECK HEIGHT : 3000 MM
- CEILING HEIGHT : 2100 MM (EXCEPT LOBBY : 2300 MM)
- FRAME SPACE : FR. -15 ~ 18, 202 ~ 238 : 600 MM, FR.18 ~ 202 : 800 MM
- DECK AREA : 1097.0 M²
- COMPLEMENT : 8 PERSON
1) 2-PERSON CABIN : 4 SET

FOR REFERENCE
Aug. - 20 - 2010
STX Offshore & Shipbuilding Co., Ltd.

ABBREVIATION AND SYMBOL TABLE			
SYMBOL	DESCRIPTION	SYMBOL	DESCRIPTION
	WATER TIGHT STEEL DOOR		WEATHER TIGHT STEEL DOOR
	A-60 CLASS FIRE RETARDING DOOR		A-0 CLASS FIRE RETARDING DOOR
	B-15 CLASS FIRE RETARDING DOOR		C CLASS FIRE RETARDING DOOR
	A-0 SUS WEATH'R DOOR (W/SCUTTLE)		NON TIGHT STEEL DOOR
	WATER TIGHT SLIDING DOOR		COLD PROVISION CHAMBER DOOR
	NON-OPENING SIDE SCUTTLE W/DEADLIGHT		NON-OPENING SIDE SCUTTLE
	HINGED SIDE SCUTTLE W/DEADLIGHT		HINGED SIDE SCUTTLE
	NON-OPENING SQUARE WINDOW		HINGED SQUARE WINDOW
	HEATED GLASS WINDOW		WINDOW WIPER
	CURTAIN		PASSAGE STORM RAIL
ABBREV.	DESCRIPTION	ABBREV.	DESCRIPTION
A.C	ARM CHAIR	A.D	ACCESS DOOR
B.C	BOOKCASE	B.R	BOOK RACK
C.B	CUPBOARD	C.C	COMMON CHAIR
C.H	COAT HOOK	C.T	CARD TABLE
CON.T	CONFERENCE TABLE	COR.T	CORNER TABLE
D.W.F	DRINKING WATER FOUNTAIN	E.C	EASY CHAIR
F.C	FILE CABINET	F.H.B	FIRE HOSE BOX
G.L	GAME LOCKER	L.K.R	LOCKER
M.L	MEDICINE LOCKER	M.T	MESS TABLE
P.C	COMPUTER TABLE	P.D	PAPER DISPENSER
R.A.C	REVOLVING ARM CHAIR	REF.	REFRIGERATOR
S.B	SIDE BOARD	S.L	STEEL LOCKER
S.R	PASSAGE STORM RAIL	S.T	SIDE TABLE
W.B	WASH BASIN	W.C	WATER CLOSET
W.R	WARDROBE	W.T	WASHING TUB
PL.C	PILLAR COVER	LC	LECTURE CHAIR
W.L	WALL LAMP		

THIS DRAWING OR DOCUMENT IS THE PROPERTY OF STX OFFSHORE & SHIPBUILDING CO., LTD. AND MUST NOT BE PARTIALLY OR WHOLLY COPIED OR USED FOR ANY OTHER PURPOSE WITHOUT PRIOR WRITTEN PERMISSION OF STX OFFSHORE & SHIPBUILDING.	
stx	HULL NO. F1004
MANAGER : S.H. YOON	TYPE NOBLE GLOBE TROTTER 2
CHECKED : C.J. YANG	TITLE ACCOMMODATION PLAN (UPPER-DECK)
S.H. KIM	
DRAWN : C.M. PARK	
TEL NO +82-2-310-2418	SCALE 1:100
DEPT OFFSHORE HULL OUTFITTING DESIGN TEAM	DATE 2010.08.20
	DWG. NO. B4003000
	REV. NO. A

stx Offshore & Shipbuilding Co., Ltd.

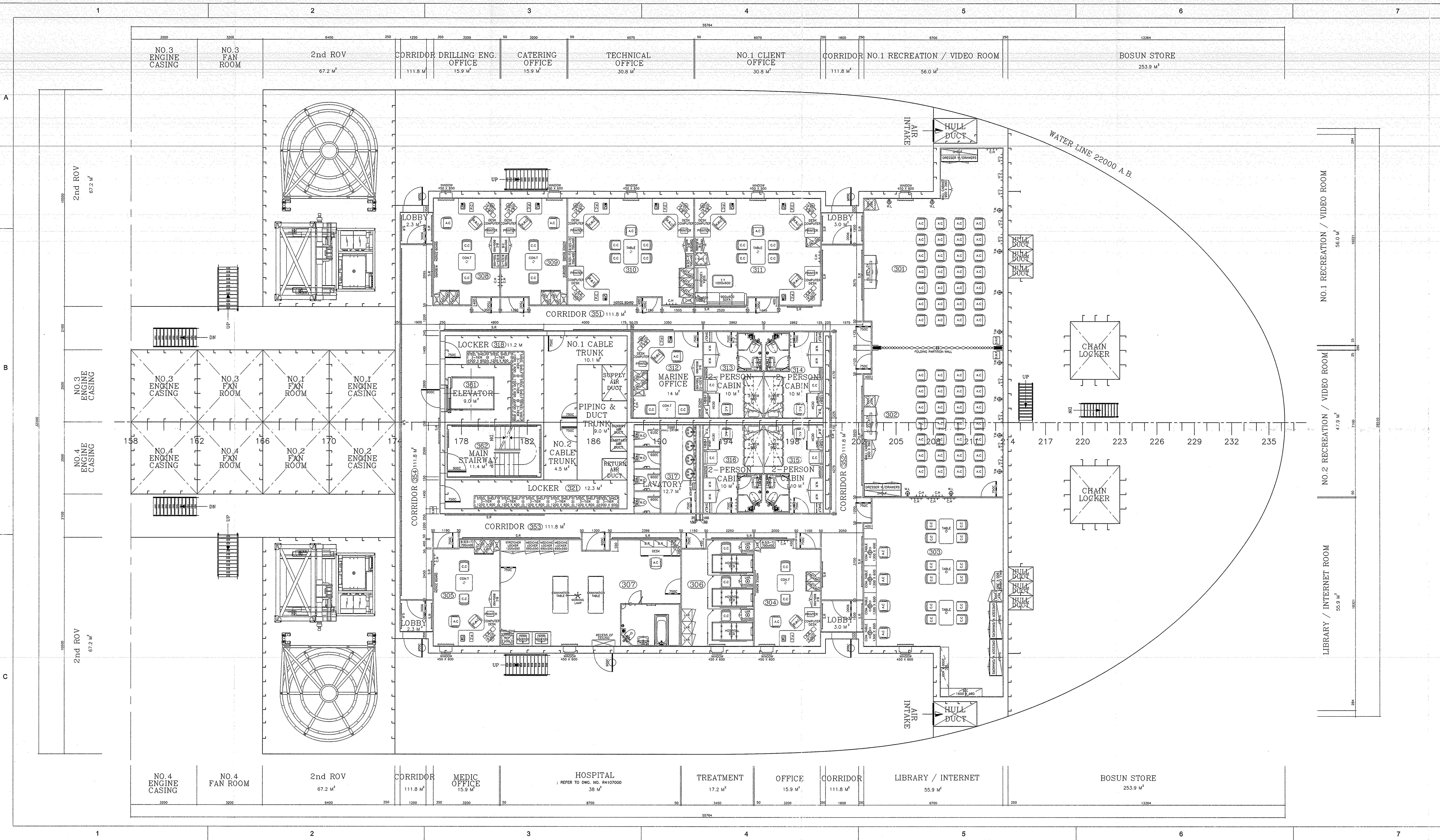

STX Offshore & Shipbuilding Co., Ltd.